

OCTOBER 1976

HEWLETT-PACKARD JOURNAL

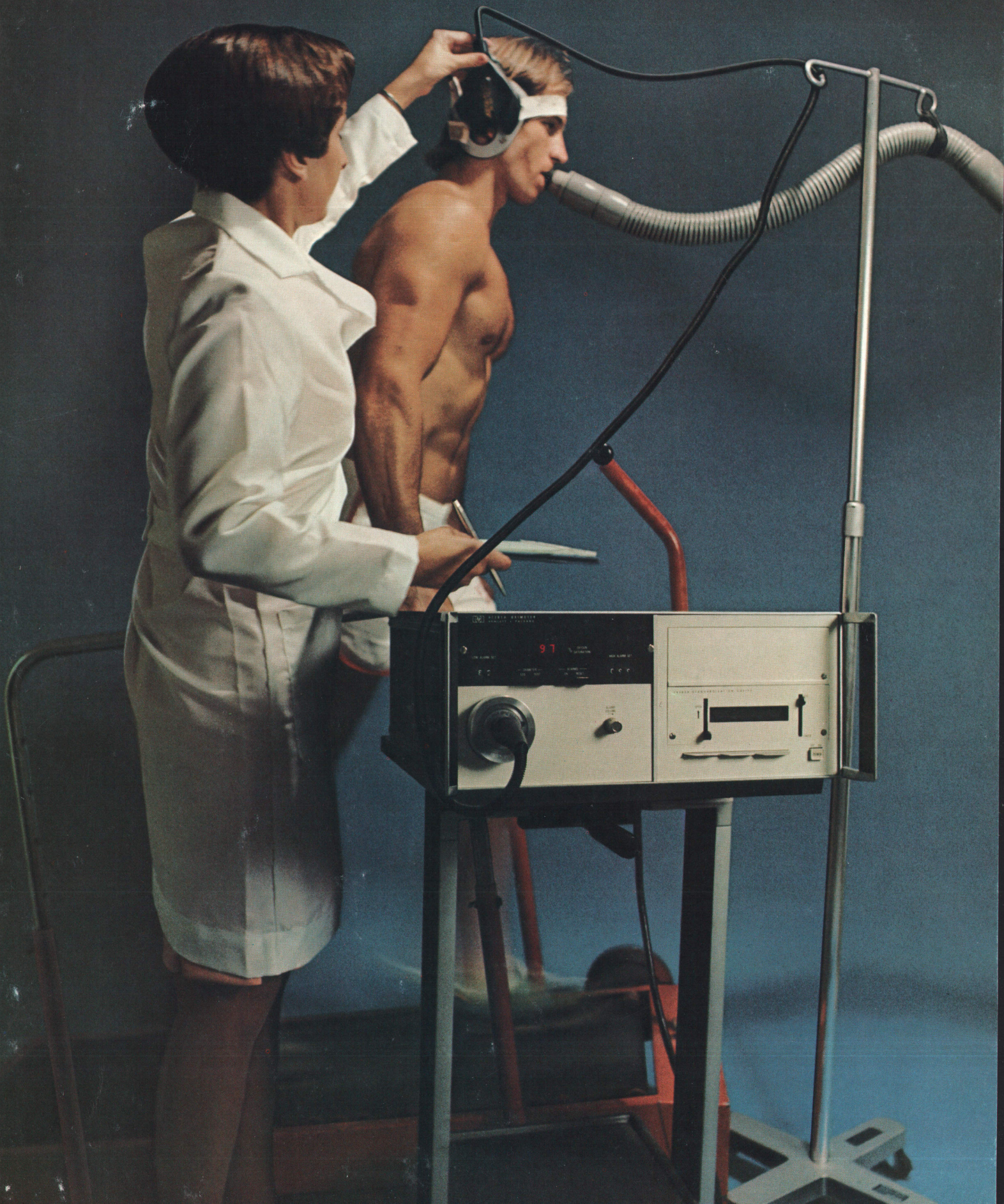

Continuous, Non-Invasive Measurements of Arterial Blood Oxygen Levels

A new oximeter gives calibrated non-invasive measurements of the oxygen saturation of hemoglobin in arterial blood, using a multiwavelength optical technique that approaches "touch-and-read" convenience.

by Edwin B. Merrick and Thomas J. Hayes

THE BASIC FUNCTION of the cardio-respiratory system is to supply oxygen to the cells of the body, a continuous supply being essential for proper functioning of every working cell. An inadequate oxygen supply can be the result of respiratory as well as circulatory disorders. Pulmonary fibrosis, emphysema, asthma, pneumonia, and a host of other respiratory problems are major causes of disability. The degree to which a patient's oxygenation status is comprised, and hence the seriousness of the problem, can be indicated by a measurement of the oxygen level in arterial blood.

Unfortunately, the amount of oxygen carried by the blood stream has not been easy to measure. Traditionally, it is done by withdrawing a sample of arterial blood and measuring the oxygen content of the sample, either by gas measuring techniques or by spectrophotometry. Besides the obvious risk involved in puncturing an artery, where pressure is high, this method indicates the oxygen content only at the time of sample withdrawal (except for some extremely difficult-to-execute on-stream methods). The delay in measured results is particularly disadvantageous in adjusting ventilators, in exercise tests, in oxygen therapy, and in many other situations where there are short-term changes in oxygen levels. What has been urgently needed is a noninjurious method of measuring blood oxygen on a continuous basis.

Methods of accomplishing this were independently proposed in 1935 by Kramer¹ and Matthes.² These methods, based on the observation that oxygenated blood is much more transparent to red light than de-oxygenated blood is, measure the transmission of light through the ear (the ear flap is an excellent place to "see" arterial blood because, as a heat radiator, it can circulate arterial blood in excess of its own needs).

This approach provides a sensitive measurement

but, unfortunately, it is also affected by the amount of blood flowing. This part of the problem was solved later by Matthes³ and refined by Millikan⁴ who made reference measurements at an infrared wavelength where the absorbing abilities of oxygenated and de-oxygenated bloods are the same. A measurement at this wavelength is thus sensitive to the amount of blood but not to the degree of oxygenation.

This method made relative saturation measurements practical where it was desired to monitor short-term changes in the blood oxygen level. However, because skin pigmentation and other absorbers

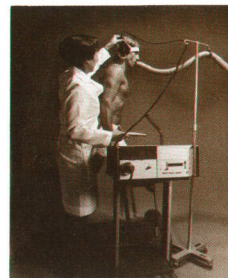

Cover: *Continuous measurements of blood oxygen levels during pulmonary stress testing, as shown here, and in many other situations involving cardio-respiratory problems are now possible with a new oximeter. It measures blood oxygen*

optically through the ear, as described in the article beginning on this page.

In this Issue:

Continuous, Non-Invasive Measurements of Arterial Blood Oxygen Levels, by Edwin B. Merrick and Thomas J. Hayes **page 2**

Laboratory Notebook **page 10**

A Signal-Level Reference

An Accurate Low-Noise Discriminator

Card-Programmable Digital IC Tester Simplifies Incoming Inspection, by Eric M. Ingman **page 11**



Fig. 1. Model 47201A Oximeter, shown here in the TEST mode with all alarm indicators illuminated, measures the percent saturation of hemoglobin continuously when the earprobe is properly placed on the ear. (The object shown to the right of the cable is the flexible light shield that covers the earprobe during a measurement.)

affect the measurement, the method is not capable of making absolute measurements.

Calibrated Measurements

A technique for overcoming the above limitation was proposed by Goldie⁵ and improved by Wood.⁶ This procedure assumes that the ear can be considered as a cuvette for blood oxygen measurements using conventional spectrophotometry. "Blank" measurements (cuvette and diluent) are made by squeezing the blood from the ear and measuring the light transmission at the two wavelengths. The light absorbance in this case may be attributed to skin and underlying tissue pigments alone and can be used to correct the readings obtained with blood present, achieving absolute calibration.

Although these developments stimulated interest in body-surface oximetry, certain remaining limitations in technique were recognized. First, any body-surface technique is limited to those subjects whose peripheral circulation is not compromised. The peripheral circulation of patients in shock usually shuts down to conserve blood flow for the vital organs so under these circumstances, any body-surface oximeter would read low.

It could also be argued with regard to this technique that:

- (a) The bloodless ear is not truly bloodless;
- (b) The optical characteristics of the compressed ear differ from those of the ear in the normal state;
- (c) The optical path in the compressed state differs

from that of the relaxed state;

(d) Any movement of the earpiece changes the measuring circumstances, requiring a remeasurement of the bloodless state;

(e) The forces required to secure the earpiece could interfere with the flow of blood.

Multiwavelength Measurements

Certain improvements to the technique that would surmount these limitations were brought to the attention of Hewlett-Packard by Robert F. Shaw, M.D., then of the Presbyterian Hospital in San Francisco. He showed that making transmission measurements at several wavelengths would result in improved accuracy and greater simplicity of measurement. This led to extensive feasibility studies at HP labs in Palo Alto, California, proving the approach to be valid. As a result, a product was defined.

The design goals for this product were to provide an instrument that could measure the oxygen saturation of blood in a subject's ear non-invasively, continuously, and accurately without involving the subject in any calibration or standardization procedures. The measurement was also to be unaffected by motion of the earprobe on the subject. Furthermore, the instrument should be easily operated by medical personnel without requiring any electronics training on their part.

These goals have been achieved in the Hewlett-Packard Model 47201A Oximeter (Fig. 1). It measures the percent oxygen saturation of hemoglobin—the

extent to which available hemoglobin is combined with oxygen—by measuring the light transmission characteristics of the ear at eight wavelengths (650 to 1050 nm) and combining the measured values to arrive at a result (see box). It makes the measurement with better than 2% accuracy (in a range of 90 to 100% at the 1σ level of standard deviation) regardless of skin pigmentation, ear thickness, or earprobe motion. It is pre-calibrated, requiring no test samples or gases for adjustment nor requiring the operator to make any zero, gain, or span adjustments other than an infrequently performed standardization procedure. The standardization procedure, which provides the instrument with basic light intensity values to serve as a reference, does not involve the patient in any way.

Straightforward Operation

Instrument operation is simple, consistent with the requirements of busy patient care areas where personnel must devote their attention to medical problems, not to instrument operation. To measure the oxygenation level of a patient, the gap in the earprobe (Fig. 2) is slipped over the anti-helix of the ear (the flat part just within the curl of the ear's outer edge) after this part of the ear has been rubbed briskly for about 15 seconds to stimulate the flow of arterial blood. A flexible light shield is then placed over the earprobe. A temperature-controlled thick-film heater within the probe maintains a temperature of 41°C at the ear for continuing stimulation of arterial blood flow after the earprobe is positioned.

The earprobe may be hand-held for the measurement or it may be attached to a headband for long-term measurements (see the cover illustration). Once the probe is in place, the instrument automatically

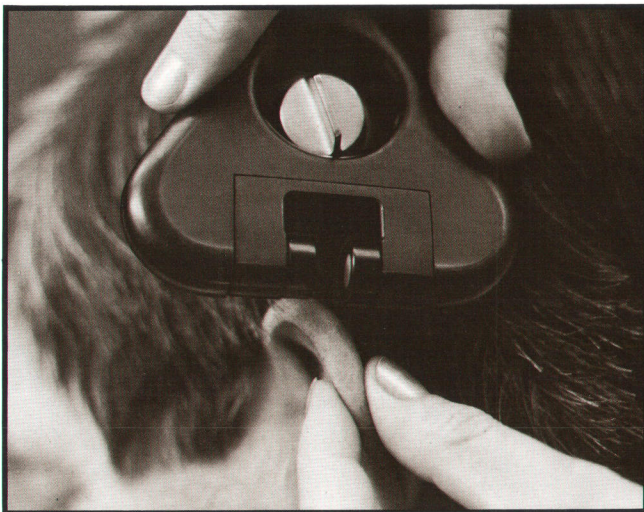

Fig. 2. The gap in the earprobe slips over the ear flap for making measurements of percent oxygen saturation. The earprobe is covered by the flexible light shield (not shown) during the measurement.

gives readings of percent oxyhemoglobin.

The oximeter is standardized at the time it is turned on by inserting the earprobe in a cavity in the front panel and pressing the OXIMETER STD pushbutton. This causes the oximeter to read the light level passing through the earprobe when there are no absorbers present. The measured values obtained at the eight wavelengths are stored in the instrument's digital processor and used as the reference values for the ear transmission measurements. The instrument will then give accurate, calibrated readings for at least four hours of continuous operation.

Operator confidence in instrument operation is enhanced by self-check facilities. Placing the earprobe in the cavity and moving the adjacent lever to CHECK inserts a glass analog of the ear into the earprobe gap and causes the instrument to make a measurement. This provides a complete system check and assures the operator that the instrument is functioning correctly if the number displayed is the same as one marked on the attached instruction card. Pressing the OXIMETER TEST button lights all of the front-panel indicators (LOW ALARM, HIGH ALARM, OFF EAR, INOP, etc.) to show that all are working, and tests the computation circuits by producing a display that should agree with a second number marked on the instruction card. The display goes to 00 after the button is held down 10 seconds, confirming operation of a processor-malfunction indication—during normal operation, the display goes to 00 any time a computed value remains unchanged for 10 seconds.

Applications

Because it reduces the complexity of determining blood oxygen levels and the time needed for doing so, and because it measures continuously, the new oximeter is being used in a wide variety of circumstances where adequate oxygen is in question or where a patient's oxygenation status can be compromised.^{7,8} For example, in many institutions it is used to screen patients suspected of having a lung problem, providing arterial information without the necessity of an arterial puncture. It assists in controlling supplemental oxygen where precise control is needed to avoid toxic levels while meeting patient requirements, and it helps in the adjustment of ventilators. It is used at a major research institution to study the breathing response of selected patients to lowered oxygen concentration.⁷ As a monitor it is proving useful during pulmonary exercise tests,⁹ sleep studies,¹⁰ surgical procedures,^{11,12} and bronchoscopy evaluations. In general, its applications range from monitoring the oxygenation of an asthmatic being treated with bronchodilators to studying an astronaut's physiological response to forces generated in a centrifuge.^{13,14}

Design Details

The basic operation of the instrument is illustrated by the diagram of Fig. 3. The light source is a tungsten-iodine lamp that has high output in the spectrum of interest. A lens system collimates the light beam and directs it through thin-film interference filters that provide the wavelength selection. These filters are mounted on a rotating wheel so they cut the light beam sequentially.

The filtered light beam then enters a fiber-optic bundle that carries it to the ear. Another fiber-optic bundle carries the light passing through the ear back to a silicon photodetector in the instrument.

A second light path is developed with a beam splitter in the path of the collimated light beam near the

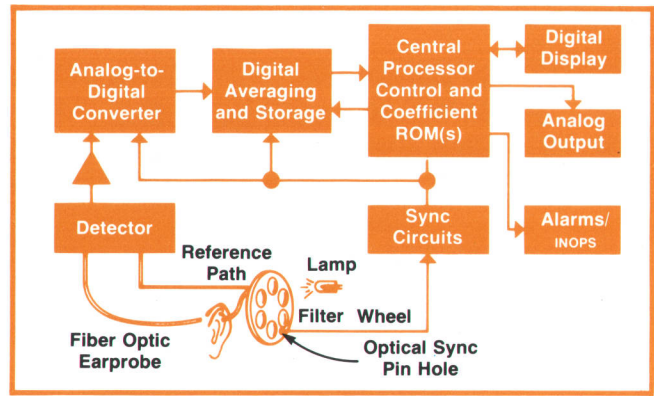

Fig. 3. Simplified block diagram of the Model 47201A Oximeter.

Oximeter Theory

The Hewlett-Packard Model 47201A Oximeter measures the percentage of oxygenated hemoglobin in arterial blood in a manner similar to the multi-wavelength spectrophotometric technique widely used by analytical chemists. In spectrophotometry, the concentrations of substances held in solution are measured by determining the relative light attenuations that the light-absorbing substances cause at each of several wavelengths.

In the Beer-Lambert model of a light-absorbing system, in this case the pinna of the ear with excess arterial blood flowing, it is assumed that the light absorbers act independently, that no combination of two absorbers has the same absorbance spectrum as hemoglobin (Hb) or oxyhemoglobin (HbO₂), and that the effects of light scattering by the ear tissue are negligible, given proper light source and detector geometry.

To understand the model, consider first a single light absorber of concentration, *c*, in a thickness, *d*:

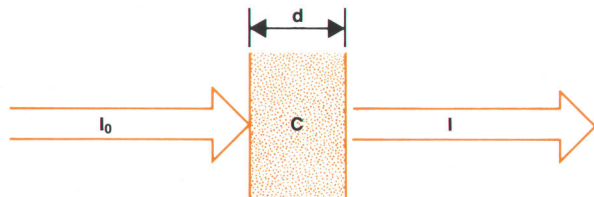

The intensity, *I*, of the light transmitted is related to the incident light, *I*₀, thus:

$$I = I_0 e^{-Kcd}$$

where *K*, known as the extinction coefficient, is a proportionality constant that varies as a function of the substance and the wavelength of the light.

The quantity *Kcd* is called the absorbance, *A*.

$$A = Kcd$$

The transmission, *T*, is defined as *I/I*₀ and since

$$A = -\log_{10}(I/I_0),$$

$$A = -\log_{10}T$$

If a mixture of two substances is contained in one sample, the absorbances (*A*₁, *A*₂) are additive:

$$T = 10^{-(A_1 + A_2)}$$

or,

$$T = 10^{-(K_1c_1 + K_2c_2)d}$$

A set of simultaneous equations can be written for total absorbance of *m* substances at each of *n* wavelengths:

$$A_1 = d(K_{11}c_1 + K_{12}c_2 + K_{13}c_3 \dots K_{1m}c_m)$$

$$A_2 = d(K_{21}c_1 + K_{22}c_2 + K_{23}c_3 \dots K_{2m}c_m)$$

$$A_n = d(K_{n1}c_1 + K_{n2}c_2 + K_{n3}c_3 \dots K_{nm}c_m)$$

In the case of the oximeter, it has been found experimentally that eight wavelengths are enough to resolve the many substances in the ear sufficiently to measure oxygen saturation.

By representing the concentration of HbO₂ by *c*₁ and the Hb concentration by *c*₂, the percent oxygen saturation is obtained by evaluating $100 \frac{c_1}{c_1 + c_2}$. This is done by applying Kramer's rule to the set of simultaneous equations with the following results:

$$\%O_2 \text{ saturation} = 100 \frac{c_1}{c_1 + c_2} = 100 \frac{A_0 + \sum_{n=1}^8 A_n \log T_n}{B_0 + \sum_{n=1}^8 B_n \log T_n}$$

where *A*_{*n*} and *B*_{*n*} are constants that were found empirically by making many measurements on many individuals and finding those constants that best fit the measured ear transmissions with respect to the oxygen saturations. The oxygen saturations were determined by conventional blood sample measurements. *A*₀ and *B*₀ were introduced to account for the absorption of non-varying components.

If boundary conditions are established by making the sums of the coefficients themselves equal to zero, i.e.:

$$\sum_{n=1}^8 A_n = \sum_{n=1}^8 B_n = 0,$$

then the solution becomes insensitive to neutral-density changes in transmittance levels. This makes the system insensitive to changes in gain, increases the range of acceptable light intensities, and contributes to freedom from motion artifacts.

When making a measurement, the Model 47201A Oximeter obtains values for the transmissions, *T*_{*n*}, by comparing the intensity of the light passing through the ear at each wavelength to the corresponding value stored during the standardization procedure. The computation circuits derive the log of *T*_{*n*}, multiply it by the appropriate constants, *A*_{*n*} and *B*_{*n*}, and manipulate the resulting terms according to the %-O₂ equation to arrive at a value of percent-oxygen saturation.

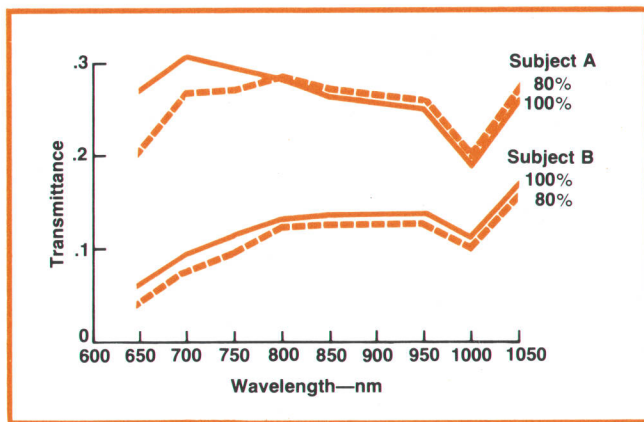

Fig. 4. Extremes in ear transmittances measured during a hospital-based study involving a broad spectrum of subjects. Measurements were made at eight wavelengths with 100% oxygen saturation and again with 80% saturation. Transmittance differences between 100% saturation (solid lines) and 80% saturations (dotted lines) are small compared to the range of transmittances encountered.

source. This path also passes through the filter wheel and then through a fiber-optic bundle directly to the silicon photodetector. The filters are spaced on the wheel such that they intercept only one light beam at a time. Thus, as the wheel turns, light at a particular wavelength travels first to the earpiece and back down to the detector, then through the reference path to the detector. Hence, the detector receives two light pulses for each wavelength. The data processor takes the ratio of the two pulses as the measured value so readings are compensated for any changes in the spectral characteristics of the light source and optical system. The wheel spins at 1300 rpm, giving about 20 readouts of all eight wavelengths per second.

The current in the photodetector may be only 0.5 nA or less during a light pulse so the detector output is amplified in a linear amplifier that has a gain of 10^8 . It is then converted to 16-bit digital words by a triple-slope A-to-D converter synchronized with the wheel rotation.

The 16-bit words are delivered to a digital signal averager that performs two functions. First, it averages out the noise content of the signal with a time-constant of 1.6 seconds. Second, it serves as a buffer, retaining the information until required by the computational process, which runs independently of the wheel rotation.

Computation of percent oxygen saturation is accomplished by a 24-bit algorithmic-state machine. It uses serial processing with the program stored in a mask-programmed ROM and the necessary coefficients of the equations stored on a field-programmable ROM.

As part of the process, the computation circuits derive the quantity of total hemoglobin seen within

the field of view of the earpiece. If this quantity is low, the instrument gives an illuminated OFF EAR indication.

From the computational section, data is transferred in pulse-decimal form to the output circuit board where it is converted to BCD for the front-panel LED display. In addition, it is converted to an analog voltage for use by an accessory trend recorder.

The BCD signal is also compared to the setting of the front-panel thumbwheel switches to determine when an alarm condition exists, front-panel lighted indicators showing when such is the case. This information is also made available to a rear-panel connector for use in monitoring systems.

Obtaining Accuracy

While the basic operation of the instrument seems straightforward enough, there were many knotty problems that had to be solved. Some light was shed on these by extensive use of computer modeling. This helped sort out the complex interrelationships between light source, filter characteristics, oxygen saturation, the presence of other light absorbers, and detector sensitivity.

The extremes in ear transmission are shown in Fig. 4. As can be seen, the change in transmission caused by oxygen saturation is small, and it is a function of the absolute transmission level as well as wavelength. This appears to be a complex relationship because the absolute level is affected by many patient-related variables, e.g. ear thickness, cartilage, skin and blood pigments, and the surface characteristics of the skin.

Considering all of the variables as simple, independent absorbers would seem to be an oversimplification, but it has proven in practice to be quite workable. The application of simple Beer-Lambert principles (see box, page 5) to an optically complex system such as the ear has proven to be surprisingly accurate.

The Beer-Lambert model not only provided the algorithm for processing transmittance measurements, but it was also useful in predicting the influence of certain system perturbations. For example, because of the differences in individual ear-transmission curves, the effects of changes in filter characteristics can in turn be affected by the characteristics of the subject.

To explore this problem, ear-transmission measurements were made on a diverse range of subjects. With this measurement data as an input for the computer modeling, it was demonstrated that the filters could degrade instrument accuracy in three ways: if the center wavelengths were not within 0.1 to 0.2 nm of those specified, if the filter bandwidth changed, and if the ratio of passband to stopband were less than 10^5 .

By working with filter suppliers it was found that a pass-to-stopband ratio of 10^5 could be obtained by

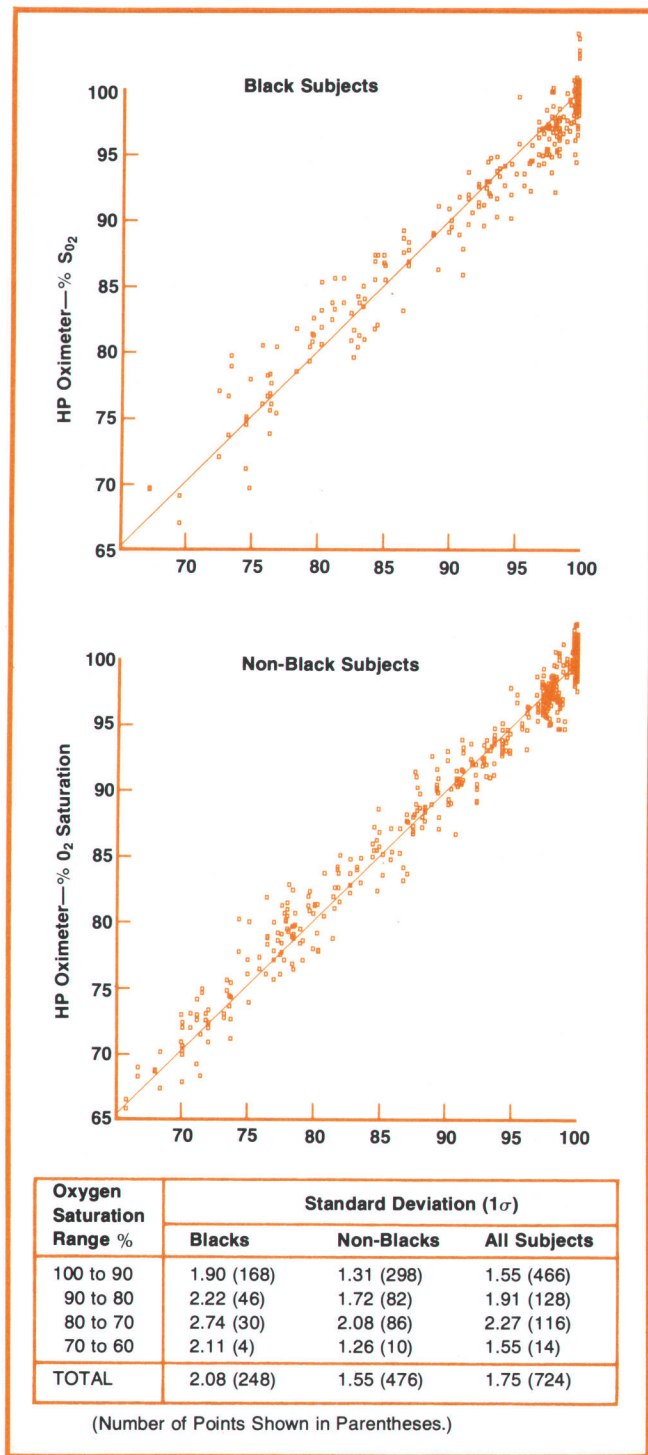

Fig. 5. Calibration series related oximeter measurements to conventional measurements of blood oxygen on arterial samples. Oxygen saturations were controlled by adjusting breathing gas mixtures.

cascading two filters, each having a ratio of 10^3 . This also controlled the bandwidth, but it reduced the energy throughput, giving a signal-to-noise ratio that required the digital averaging to overcome the effects of the noise.

The best center wavelength specification that could

reasonably be obtained was ± 0.5 nm. This presented a serious problem, as this could cause errors as high as $\pm 8\%$. To confirm this, a set of filters was ordered with six times the ± 0.5 -nm center-wavelength deviation, all chosen to accumulate the worst way. Installed in an instrument, this set caused the instrument to read 130% when a subject's oxygenation level was 100%, and 112% when the actual level was 70%.

The data obtained from this instrument, however, provided a means for deriving correction factors with respect to the center-wavelength deviation of the filters. When these correction factors were applied to the instrument that had the six-times worst-case filters, results were nearly indistinguishable from instruments using optimum filter sets. In production instruments, the center wavelengths of each filter set are measured and the coefficients of the equation are modified according to the deviations. These coefficients are then entered into the field-programmable ROM for the instrument that uses that filter set.

Interchangeable Ear Probes

A major design effort involved the optical characteristics of the earprobe/cable assembly. One requirement for the probe was interchangeability, allowing any probe to be used with any instrument. The ear should be treated, of course, as a scattering light transmitter. Changes in measurement conditions caused by probe movement and changes in the geometry of illumination caused by various ear thicknesses and shapes were minimized by using a probe with a fixed ear gap and with uniform diffusion paths for both incident and transmitted light.

Uniform diffusion is accomplished by tandem diffusers. The tungsten light emerges from the fiber-optic bundle at many different angles, creating non-uniform and nonrepeatable irradiation patterns that differ from unit to unit and even differ in the same unit when the cable is moved. These patterns are projected on an opal-glass diffuser that redistributes the illumination before projecting it on a second diffuser. The second diffuser produces evenly distributed radiation on the ear.

A similar diffusion system evenly distributes the scattered illumination received from the ear. This diffusion system provides uniform radiation angles and uniform sensitivity across the input to the receiving fiber-optic bundle, thus providing the uniform optical geometry needed for making precise measurements on scattering samples, such as the ear.

The Baseline

Instrument calibration ultimately rests on a hospital based study (as yet unpublished) from which the processing coefficients were determined. This study involved volunteers, carefully selected to represent a broad distribution of racial characteristics,

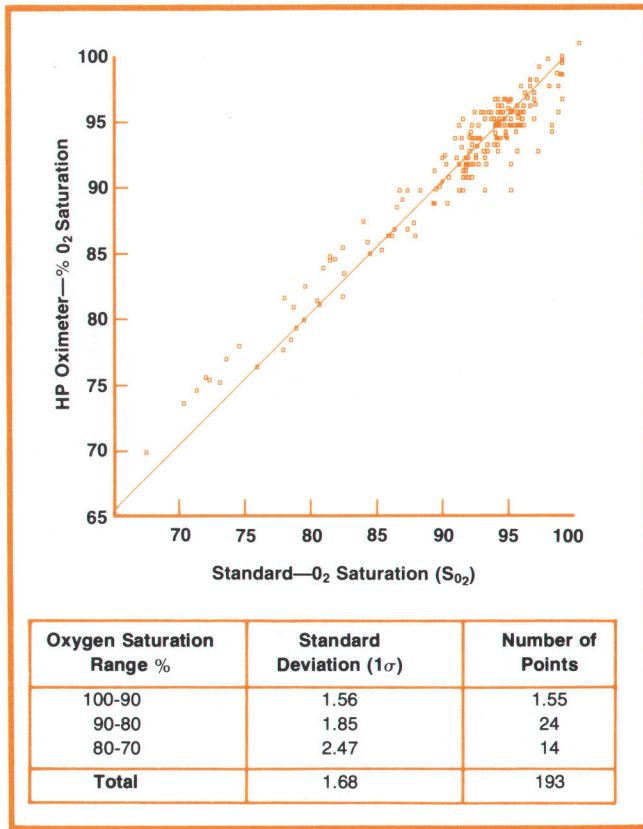

Fig. 6. Independent verification of oximeter performance was obtained from clinical trials at several hospitals. Comparison measurements plotted above are a composite of results from five hospitals using six HP oximeters and seven different analytical instruments. Results are within the oximeter's accuracy specifications.

both male and female, smokers and non-smokers, who were exposed to hypoxic breathing mixtures

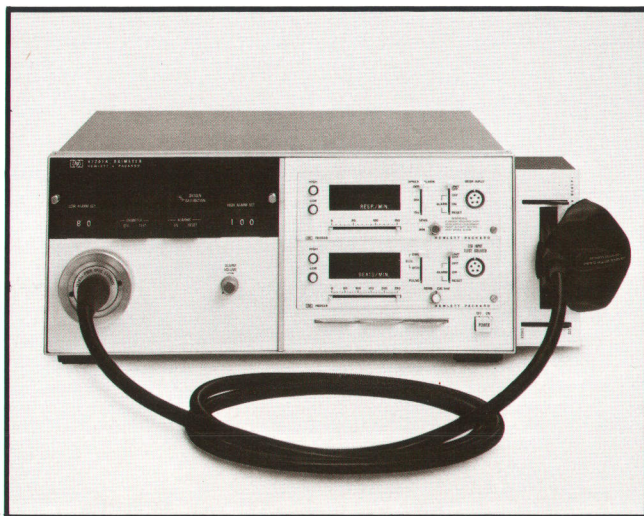

Fig. 7. Oximeter has space for optional patient-monitoring modules to give simultaneous measurements of heart rate, pressure, temperature, or respiration. Standardization cavity then mounts on the side of the instrument.

(Fig. 5). Simultaneous arterial blood-sampling and ear-transmission measurements produced sufficient data to derive a coefficient set that minimized error when blood-sampling results are compared with values calculated from ear-transmission measurements. The spectrophotometric reference standard was calibrated in terms of gas-content measurements using the Van Slyke procedure.

These results were verified in several hospital studies involving several instruments before the instrument was formally introduced (Fig. 6). Independent studies published by several investigators have provided confirmation.^{7,8,11,14,15}

Instrument-to-instrument variability is a useful measure of the control exercised over component specifications. The following table indicates the performance of five instruments on twenty-eight subjects, both when breathing room air and when breathing 100% oxygen. The close agreement from instrument to instrument shows the level of performance obtained.

Instrument	Room Air		100% O ₂	
	Average Oxygen Saturation	Standard Deviation	Average Oxygen Saturation	Standard Deviation
1	97.20	0.85	99.59	0.92
2	97.20	0.98	99.73	0.97
3	97.25	0.92	99.80	0.65
4	97.25	1.01	99.67	0.74
5	97.24	1.00	99.76	0.72
All Points	97.23	0.94	99.71	0.80
Instrument Variability (5 instruments, 28 subjects)				

Acknowledgments

There were many investigators, Kramer through Shaw, whose efforts led to the development of body-surface oximeters and formed the theoretical basis for this instrument. During the feasibility studies at HP Labs, Gerry Alonzo was project leader, making many contributions including software development and microprocessor design. The CPU was designed by Charlie Hill with important contributions from Doug Smith. Dave Sidlauskas was responsible for the simulation theory and analog design, and contributed to the calibration protocol. The difficult problems of optical design including the earprobe were the responsibility of Dave Miller (temporary transfer from the Waltham Division), ably assisted by Rich Marconi.

During the product design phase at the Waltham Division, Larry Nielson contributed in many ways but was primarily responsible for electronic design and systems compatibility. Al Bond designed the filter-wheel assembly, the interfacing to the fiber-

optic probe, and other mechanical aspects of the instrument. Roy Stelling provided the heater circuits and contributed in other ways to the electronics. Dave Barkman formulated the calibration protocols and contributed extensively to the modeling concepts. Al Tykulsy developed all the software for the computer testing and Bob McClung handled the verifica-

tion requirements and the development of clinical experiences. A multitude of manufacturing problems were ably handled by Ray O'Connell and Bill Kole. 

Edwin B. Merrick

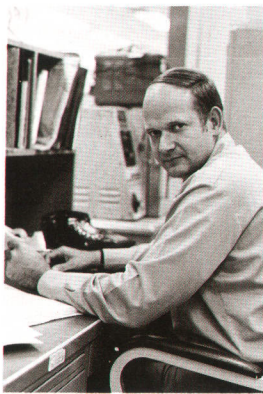

Ed Merrick joined Hewlett-Packard in 1963 upon getting a BSEE degree at the University of New Hampshire. Initially he worked on several of the 780 series patient-monitoring modules and then went on to project leadership of the oximeter. He is presently Engineering Manager for respiratory products. Ed enjoys camping, mountain climbing, and cruising the Maine coast in his 25-foot Albin, but recently most of his and his wife's spare time has been devoted to restoring a house and barn originally built in 1783. They have three children.

Tom Hayes

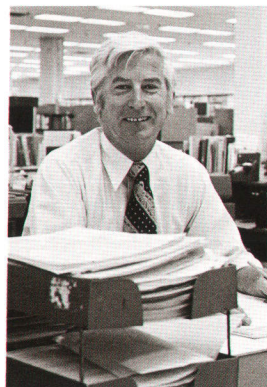

Tom Hayes obtained a BS degree in chemistry from Boston College and did some graduate work in physical chemistry at MIT before joining the Sanborn Company (now the Waltham Division of Hewlett-Packard) in 1957. Since being with the company he has worked on coagulation analyzers, blood-cell counters and other clinical instruments and did some product training before becoming involved in the development of testing protocols for the oximeter. He is now product manager for the oximeter. He lives in Canton Massachusetts with his wife and seven children, enjoys outdoor activities, and is a confirmed "do-it-yourselfer".

SPECIFICATIONS

HP Model 47201A Ear Oximeter

Model 47201A is calibrated to read percent oxygen saturation of functional hemoglobin. It reads the oxygen saturation of blood in the ear provided sufficient hemoglobin is present in earpiece field of view. Reading corresponds to arterial saturation if ear perfusion is far in excess of metabolic demands.

ACCURACY (± 1 sigma): $\pm 1.7\%$, 90-100% range
 $\pm 2.0\%$, 80-90%
 $\pm 2.3\%$, 70-80%
 $\pm 2.6\%$, 60-70%
 Unknown, 0-60%.

SETTLING TIME: Settles to within 1% of reading approximately 20s after earpiece is applied to well-perfused ear.

RESPONSE TIME: Normally 2.3s for 67% response to step change in saturation. Changeable by internal jumper to 1.5 or 4.7s.

DRIFT: 0.25%/hour after 15 m warm-up.

INTERFERING SUBSTANCES: Bilirubin concentration greater than 10 mg % causes inaccurate readings, typically 2 to 4% low in a range of 10 to 25 mg % bilirubin. "Cardiogreen" used in cardiac output studies causes transiently high readings.

EARPROBE TEMPERATURE: 41.0°C ± 1 °C.

REAR-PANEL ANALOG OUTPUT: 2.5 to 5V (adjustable) for 100% oxygen saturation.

REAR-PANEL SYSTEM CONNECTOR OUTPUTS: Oxygen saturation analog output, HI and LO alarms, and INOP.

PATIENT ISOLATION (measured from earprobe to third-wire ground): $\geq 20\text{M}\Omega$ at 3000V rms, 60 Hz, 40°C and 95% relative humidity.

OPERATING ENVIRONMENT: meets specifications in a temperature range of 0 to 32°C after warm-up provided fan filter is clean and instrument is standardized once every few hours. For temperatures from 32°C to 45°C, instrument must be restandardized for each 1°C change in ambient temperature. Above 45°C, instrument shuts down and turns on INOP indicator. Operates at all levels of humidity short of those that produce condensation.

POWER: 115/230 Vac, 50/60 Hz, 160VA.

DIMENSIONS: 191 mm H \times 425 mm W \times 425 mm D (7.5 \times 16.75 \times 16.75 in).

WEIGHT: 16.7 kg (37 lbs)

PRICE IN U.S.A.: \$8200.

MANUFACTURING DIVISION: WALTHAM DIVISION

175 Wyman Street

Waltham, Massachusetts 02154 U.S.A.

References

1. K. Kramer, "Ein Verfahren zur Fortlaufenden, Messung des Sauerstoffgehaltes im Stromenden Blute an uneroffneten Gefassen," *Zeit. f. Biologie*, 96:61, 1935.
2. K. Matthes, "Untersuchungen uber die Sauerstoffsattigung des Menschlichen Arterienblutes," *Arch. f. exper. Path. u. Pharmacol.*, 179:698, 1935.
3. K. Matthes and F. Gross, "Fortlaufende Registrierung der Lichtabsorption des Blutes in Zwei verschiedenen Spektralbezirken," *Arch. f. exper. Path. u. Pharmacol.*, 191:381, 1938.
4. G.A. Millikan, "The Oximeter, an Instrument for Measuring Continuously Oxygen Saturation of Arterial Blood in Man," *Rev. Sci. Inst.*, 13:434, 1942.
5. E.A.G. Goldie, "A Device for the Continuous Indication of Oxygen Saturation of Circulating Blood in Man," *J. Sci. Inst.*, 19:23, 1942.
6. E.H. Wood and J.E. Geraci, "Photoelectric Determinations of the Arterial Oxygen Saturation in Man," *J. Lab. and Clinical Med.*, 34:387, 1949.
7. N.A. Saunders, A.C.P. Powles and A.S. Rebeck, "Ear Oximeter 1976.
8. I. Lintzmayer, I. Aghdasi, S. Ishikawa, "Clinical Applications of Ear Oximetry," *Clinical Research*, April 1975.
9. H. PXVII Nordiske Lungelege Kongress, Oslo, Norway, 13-15 June 1976.
10. M.R. Flick and A.J. Block, "Nocturnal Hypoxia," Abstracts from *American Review of Respiratory Disease*, Vol. 113, No. 4, April 1976.
11. A.N. Siffer and W.E. Martin, "Evaluation of an Eight Wavelength Arterial Ear Oximeter," Abstracts of Scientific Papers 1975—Annual Meeting of the American Society of Anesthesiologists.
12. A.J.L. Schneider, J.F. Kreul and R.M. Zollinger, "Patient Monitoring in the Operating Room—An Anesthetists Viewpoint," *Medical Instrumentation*, 10:105, 1976.
13. J.S. Kirkland, J.A. Kennealy, A.K. West, and W.J. Buehring, "Ear Oximeter Monitoring of Arterial Saturation During +GZ Stress," Abstracts from 1976 Annual Scientific Meeting of Aerospace Medical Association, Bal Harbour, Florida.
14. E.L. Besch, J.H. Miller, F.W. Baumgardner, R.R. Burton, K.K. Gillingham, R. McPherson, and S.D. Leverett, "Physiologic Calibration of an Ear Oximeter During Human Exposure to +GZ," Abstracts from 1976 Annual Scientific Meeting of the Aerospace Medical Association, Bal Harbour, Florida.
15. M.R. Flick and A.J. Block, "Cardiac Arrhythmias in Chronic Obstructive Lung Disease (COLD): Effect of Low Flow Oxygen Administration," Abstracts from *American Review of Respiratory Disease*, Vol. 113, No. 4, April 1976.
17. E. Merrick, "A Multiwavelength Ear Oximeter," *Biocapt 75—International Conference on Biomedical Transducers*, Paris 1975.

Correction

In our September 1976 issue, in Fig. 4 on page 12, switch S_D is shown connected to e_1 when it is actually connected to e_2 and vice versa. Also, the phase shifts shown in Fig. 4 for the C_3 -D measurement should be 0° in step 3 and 270° in step 4. The text of the article is correct.

Laboratory Notebook

A Signal-Level Reference

The accuracy of instruments that measure signal level can be enhanced by including a calibration source within the instrument. The diagram below is an example of how this can be done inexpensively. This circuit generates an RF signal that has a highly stable amplitude level for use as a calibration reference.

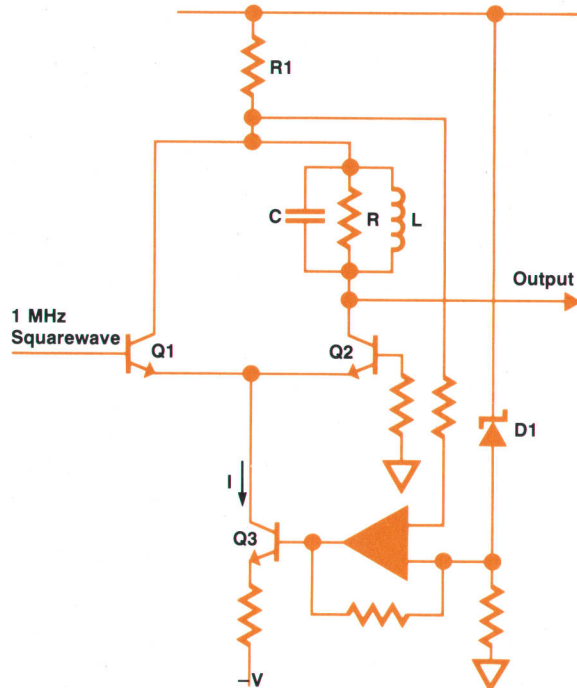

A stable current, I , is established by comparing the voltage drop across resistor $R1$ to a reference voltage produced by temperature-stable zener diode $D1$, and using the result to control constant current generator $Q3$. The stabilized current flows alternately in transistors $Q1$ and $Q2$ as the transistors are switched by the squarewave from a local oscillator within the host instrument.

The squarewave current flowing through the resonant circuit in the $Q2$ collector circuit produces an output sine wave that has a peak-to-peak value $Z_{RLC} \times I \times 4/\pi$. ($4/\pi$ is the ratio of the fundamental to the peak-to-peak amplitude of a square wave.)

The impedance Z_{RLC} is stabilized by suitable choice of components and, as mentioned previously, I is stabilized by comparison to a zener voltage. Using the voltage across $R1$ to stabilize I eliminates the effects of temperature-induced variations in transistor α . As a result, the circuit's output amplitude stability is within 0.01 dB over a temperature range of 0 to 55°C.

This circuit, operating at 1 MHz, is used in the Model 3745A Selective Level Measuring Set (Hewlett-Packard Journal, January 1976) to calibrate the instrument automatically at the start of each measurement.

J. Reid Urquhart
Hewlett-Packard Limited
South Queensferry, Scotland

An Accurate, Low-Noise Discriminator

Pulse-count discriminators are often used where very good linearity in frequency-to-voltage conversions is a requirement. They achieve linearity by generating a narrow, constant-width pulse for each cycle of the input waveform, and integrating the pulses to obtain a dc level proportional to input frequency. Assuming that the integrator response is sufficiently fast, output linearity is a function of the constancy of pulse width.

The width of the pulses is usually determined by a multivibrator with an RC timing circuit. However, because the slope of the RC discharge curve causes some uncertainty in the timing of the multivibrator reset, there are minor variations in pulse width and hence in the dc output. If these variations are not a function of pulse rate, then the result is simply the addition of noise to the dc output.

Achieving low noise thus requires a good "time standard" for determining pulse width. A high-Q pulse-forming network can accomplish this.

A discriminator based on this principle is shown in the diagram. The input waveform is squared in line receivers connected as Schmitt triggers to reduce any AM sensitivity in the discriminator, and the resulting square wave drives a pulse-forming network. The network's input impedance is similar to that of a shorted transmission line, going to zero shortly after the occurrence of each square-wave transition and thereby forming narrow pulses. The positive pulses turn on a current switch and integration of the current pulses obtains the dc output.

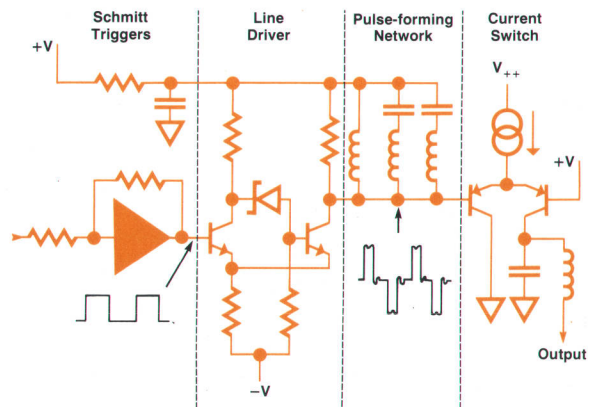

A typical application for this type discriminator is in the YIG oscillator control loop for the sweep-frequency generator of the Model 8505A Network Analyzer (Hewlett-Packard Journal, July 1976) where maximum oscillator stability was desired. This discriminator operates over a range of 0.5 to 13 MHz with a pulse width of 22 ns. Since discriminator noise is directly related to switching time, ECL line drivers are used for the Schmitt triggers to obtain very fast pulse transitions. The result is residual FM of less than 20 Hz rms in the sweep-frequency output over the 0.5-to-13-MHz range.

For operation over a 0.5-to-130-MHz range, the system output frequency is divided by 10 before being applied to the discriminator. Residual FM is then 200 Hz rms.

Gerald Ainsworth
Stanford Park Division
Palo Alto, California

Richard Pope
Santa Rosa Division
Santa Rosa, California

Card-Programmable Digital IC Tester Simplifies Incoming Inspection

It's inexpensive, easy to set up to test a wide variety of digital IC's, and easy to operate. Interfaces for many automatic IC handlers are available.

by Eric M. Ingman

WHEN A COMPONENT FAILS in a piece of electronic equipment, locating and replacing it can be a costly process requiring a skilled technician. To reduce the possibility of such failures, components are subjected to various tests before they are assembled into equipment. Testing begins with the component manufacturer. However, no matter how complete a manufacturer's production tests are, a certain percentage of the components shipped will be found to be defective when they arrive at their destination. This is true of any manufactured product. For this reason, equipment manufacturers are

turning more and more to 100% inspection of incoming components. Every faulty component found in incoming inspection can save five to ten dollars in board rework costs.

Besides performing the appropriate logical function, digital integrated circuits must meet input, output, and power supply voltage and current specifications, and propagation, rise, and fall time specifications. Although there are automatic systems that test all of these parameters, they are too complex and costly for most equipment manufacturers' incoming inspection departments. Less costly is the approach

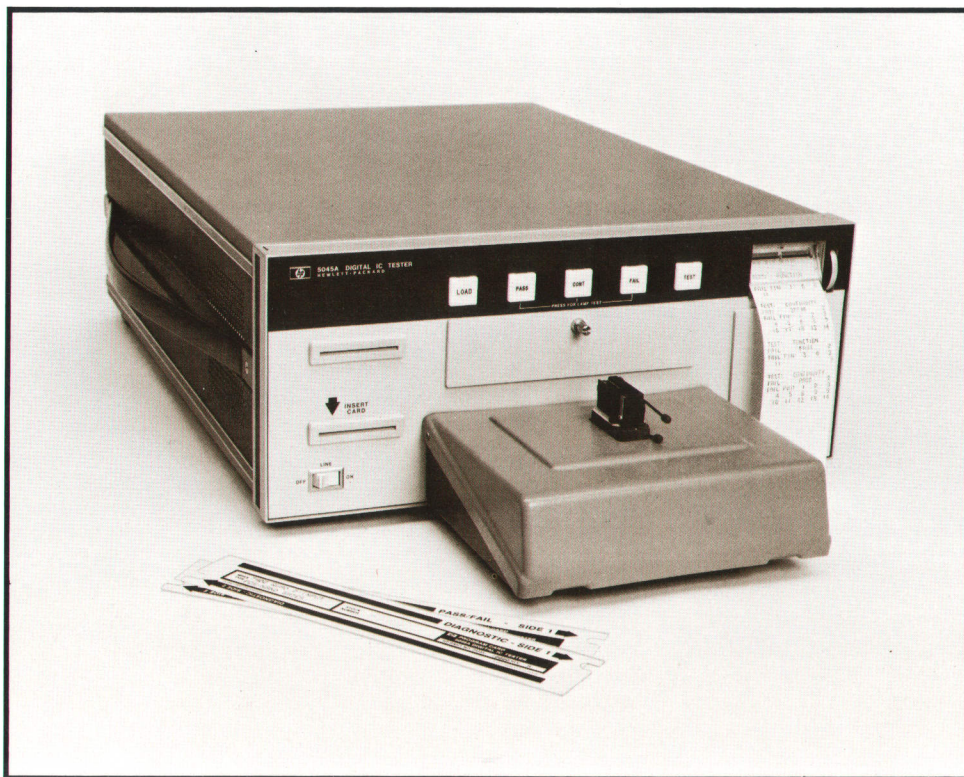

Fig. 1. Model 5045A Digital IC Tester is programmed by means of factory-prepared prerecorded magnetic cards to test a wide variety of commercially available digital integrated circuits. A built-in printer provides a record of test results and failure analyses.

most often taken: each circuit is tested functionally and its voltage and current parameters are checked.

Testers that do this kind of inspection are usually programmed to test different types of integrated circuits in one of two ways. Some use interchangeable printed circuit boards or cards. Others are programmed by setting limit voltages and currents on thumbwheel switches and making connections to the device under test by means of a pushbutton matrix. The former method has the disadvantage that with the many thousands of different integrated circuits available today the program card library can become large and expensive. The latter method isn't well suited for use by unskilled personnel on a production basis. Also, a number of different tests can't easily be made on the same device.

Software programming can eliminate all of these disadvantages. Testers that are fully software-programmed are only now becoming available.

New IC Tester

The new HP Model 5045A Digital IC Tester (Fig. 1) is a software-programmed tester designed to minimize the incremental cost associated with testing each different IC type. Both functional and dc parametric tests for a particular IC are programmed by an inexpensive magnetic card (see Fig. 2). Preprogrammed cards for testing a wide variety of standard ICs are listed in HP's IC Program Catalog. The tester is easy to operate; an operator can be trained to use it in a few minutes.

Model 5045A tests a broad spectrum of logic families, including ECL, CMOS, TTL, RTL, HTL, and DTL. 16-pin capability is standard, 24 optional. A built-in printer produces a permanent record of IC

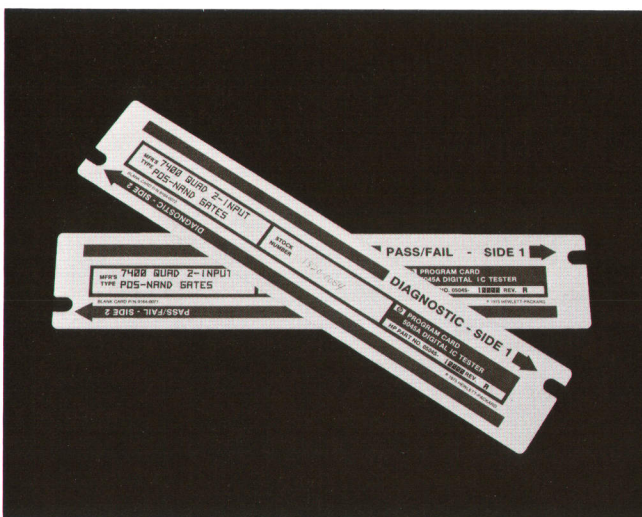

Fig. 2. Test package for each circuit type includes two tests, each on a separate preprogrammed card. Pass/fail test is for rapid functional testing. Diagnostic is the same test with more detailed failure analysis.

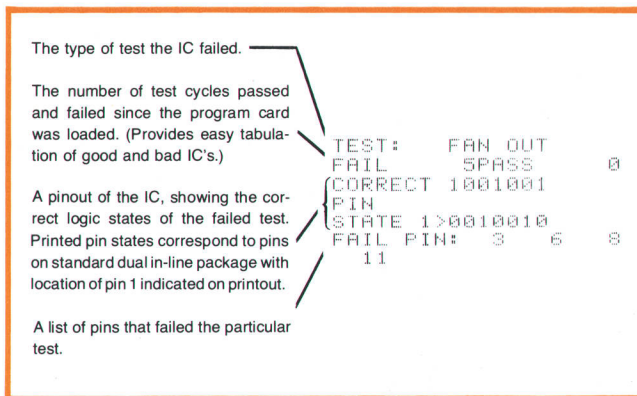

Fig. 3. Typical printout of test results.

failures, including voltage and current data on failing pins. The tester generates its own ROM test programs by exercising a known good ROM, storing its outputs, and then recording the complete program on a blank magnetic card. Confidence in the reliability of test results is increased by a built-in self-check capability.

The 5x27-cm magnetic test program cards are preprogrammed on a computer system. Testing a device involves inserting the appropriate magnetic card for that device type, fitting the correct test socket if it is not already in place, plugging in the device to be tested, and pressing the test button. If the device fails one of the tests, the name of the test, the number of passes and failures since the magnetic card was

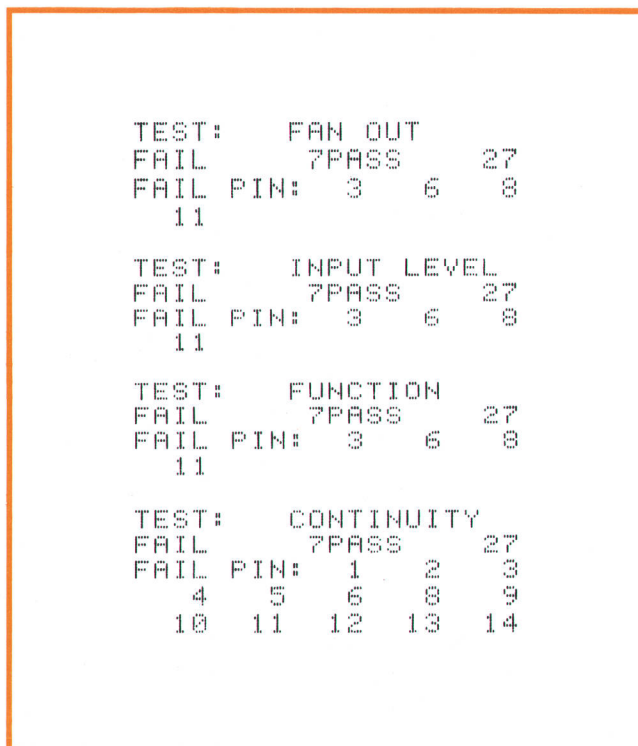

Fig. 4. The tester can print out all the tests and pins on which failures occur for a particular IC.



Fig. 5. The V AND I RESULTS switch causes the tester to vary the voltage and current on failed pins until the device passes and then print those voltage and current readings. See Fig. 6.

loaded, the logic states applied to and expected from the device, and the pins that failed are printed out on the built-in 20-character thermal printer (see Fig. 3). The test can be terminated on the first failure, or the tester can hold on fail for further examination of the failed condition and be manually stepped to the next failure, or all the tests and pins on which failures occur can be printed out (see Fig. 4).

So the user can tell how close a device came to passing, the V AND I RESULTS switch on the front panel (see Fig. 5) causes the voltage and current to be varied automatically on failed pins until the device passes, and those voltage and current readings are then printed out (Fig. 6). On pins that do not have failures the programmed test limits are printed. To verify correct loading of data from the magnetic card a

The center column contains the voltage reading.

The right-hand column contains the current reading in milliamperes.

"L" indicates the pin's programmed limit.

The direction of current flow is with respect to the device under test. Current is conventional current, flowing from positive to negative. Any current flowing out of a device is given a minus sign on the printout.

Failed pins are listed twice: Top listing—programmed constant voltage, resultant current. Bottom listing—programmed constant current, resultant voltage.

```

TEST:      FUNCTION
FAIL:      2PASS    44
1  0.8LV   -5LMA
2  2LV     5LMA
3  2.4LV   -0.4LMA
4  2LV     5LMA
5  2LV     5LMA
6  0.415LV 13.88 MA
6  0.462 V  16LMA
7  0LV     -200LMA
8  0.415LV 16LMA
9  2LV     5LMA
10 2LV     5LMA
11 0.415LV 12.96 MA
11 0.482 V  16LMA
12 2LV     5LMA
13 2LV     5LMA
14 4.75LV  200LMA
CORRECT 1110110
PIN
STATE 1>0111100
FAIL PIN:  6  11

```

Fig. 6. V and I results printout tells the user how close the device came to passing.

checksum is done and RELOAD printed if an error is detected.

The tester can also record programs stored in its program memory, so cards can be duplicated and the output pattern of ROMs to be tested can be self-



Fig. 7. The test deck of the 5045 IC Tester can be removed and mounted on an automatic handler. Interface electronics are available for many commercially available handlers.

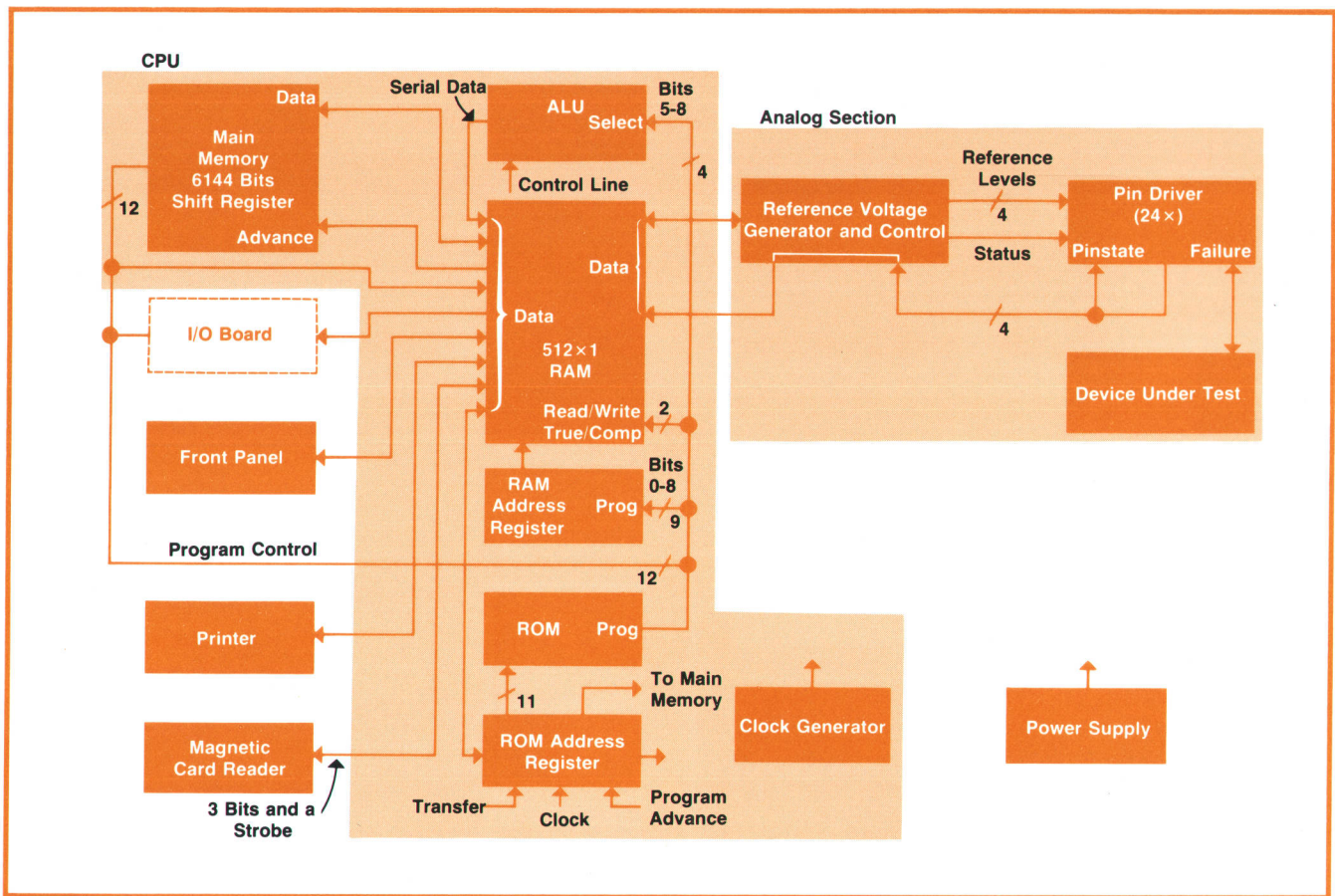

Fig. 8. 5045A IC Tester block diagram.

programmed. In the latter case a program card for that type of ROM sets up voltage and current parameters, organizes the tests to be performed, and defines input, output, and supply pins. The user then inserts a good ROM with the desired pattern and tests it once. The 5045A stores the output pattern, and subsequent tests use the stored output pattern as the reference truth table. The entire program including the output pattern can be recorded on a blank card for future use.

The 5045A IC Tester can be operated as a stand-alone tester with the devices to be tested inserted manually, or connected to an automatic handler that automatically inserts the ICs into the test socket (Fig. 7). The fast circuitry that must be located close to the test socket is contained in a removable "tongue". For handler operation the tongue is removed from the tester and mounted on the handler and a special interface board connects directly to the test socket. Connection between the tester and tongue is by means of a multiconductor cable. Interface boards are available for many commercially available handlers.

Inside the Tester

The 5045A IC Tester block diagram, Fig. 8, can be divided into three sections.

- The analog section and its associated interface circuit contain the pin driver and test head electronics, and the reference voltage generator and control, which stores the test limits for each pin in a digital memory and converts them to analog form.
- The CPU (central processing unit) is the heart of the digital part and is the controller of the 5045A.
- The front panel, printer, and magnetic card reader provide the interface with the operator.

The pin driver circuit (see Fig. 9) is the same for each pin of the IC under test. Any pin can be an input, output, clock, or power supply pin. Ground relays on selected pins provide a low-impedance ground path on all common ground pin arrangements.

Each pin driver has two current generators, one for positive current and the other for negative. Each current generator has two program-controlled current ranges, HI and LO, and can be programmed to turn on or off depending on whether the pin driver is in the one or the zero state. When the pin driver is a source, such as when it is to drive an input or be a power supply, the positive current generator is turned on if the pin driver is in the one state and the negative current generator is turned on if the pin driver is in the zero state. When the pin driver acts as a load the

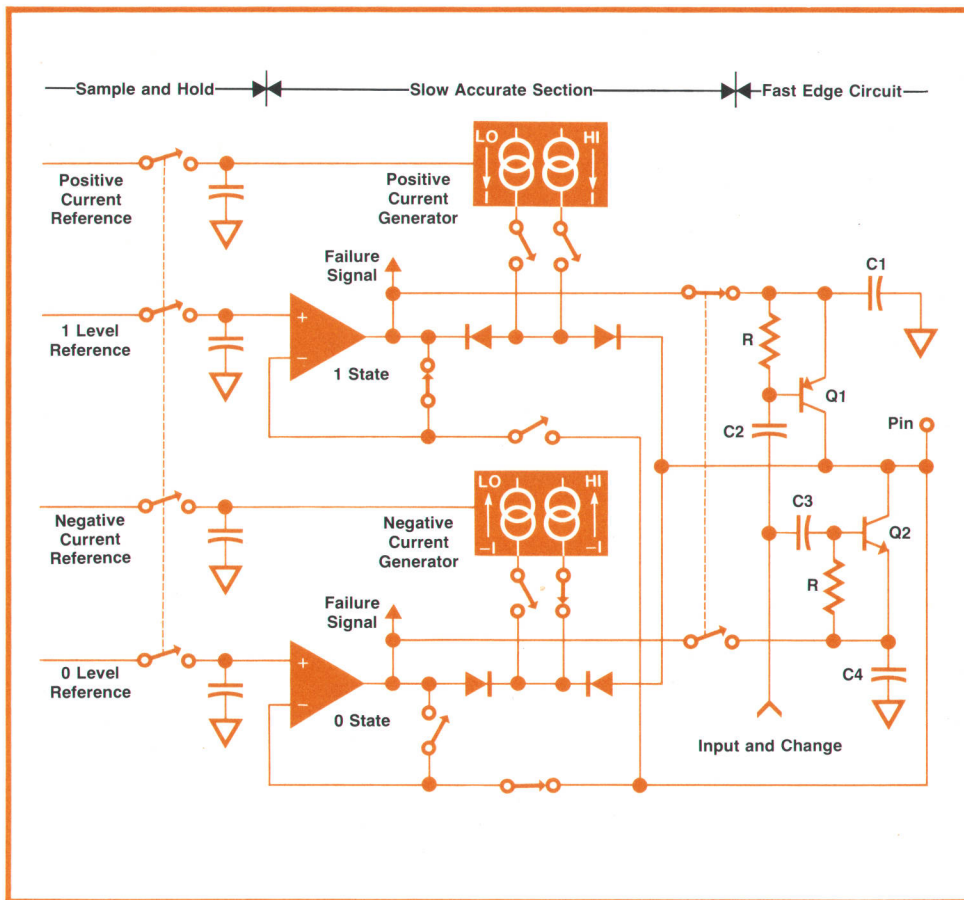

Fig. 9. Pin driver circuit is the same for each pin of the IC under test. Any pin can be an input, output, clock, or power supply pin. As shown here, the pin driver is acting as a source in the zero state and the HI current mode.

reverse is true. Each current generator can be programmed on in both states to act as a pull-up on open-collector outputs or for driving pins that have the same polarity of input current in both states. Each current generator is connected to the midpoint of two back-to-back diodes so the maximum current that can flow to the pin is equal to that from one current generator.

As an example of pin driver operation, suppose it is to be a source and is in the zero state. The negative current generator is on and the positive generator is off. The only source of current to the pin is the pair of back-to-back diodes connected to the negative generator, so the zero-state circuits have control of the voltage applied to the pin. The inverting input of the operational amplifier is connected to the test pin via a CMOS switch so that a negative feedback loop is established around the operational amplifier. So long as the pin current does not exceed the current from the negative current generator the voltage applied to the pin is equal to the zero reference level. If the current drawn by the device under test exceeds the current limit programmed into the current generator, the output of the operational amplifier is driven hard negative. This constitutes a failure.

When the pin driver switches to the one state the CMOS switch in the feedback path from the test pin

opens and the CMOS switch connected to the output of the operational amplifier closes, so the output of the zero-state operational amplifier equals the zero reference level. When the zero-to-one transition occurs a fast edge is applied by transistor Q1, whose emitter is at the one voltage level. The transition is applied to the base of Q1 through a CR network, causing Q1 to turn on and saturate, bringing the test pin quickly up to the one level. When capacitor C2 discharges Q1 turns off. Meanwhile, the slower, more accurate test signal from the one-state operational amplifier and the positive current generator settles down and controls the test pin after Q1 turns off. Capacitor C1 is large and is charged through the CMOS switch from the output of the one-state operational amplifier while the pin driver is in the zero state. The fast edge circuits are mounted close to the test socket in the tester's tongue and are activated only when the pin driver is programmed as a source.

Operation is similar when the pin driver is used as a load, except that in the zero state the positive current generator is on and in the one state the negative current generator is on. The voltage on the test pin is controlled by the device under test and the operational amplifier indicates whether the voltage is less than or greater than the reference voltage. In the zero state if the test pin has a voltage higher than the

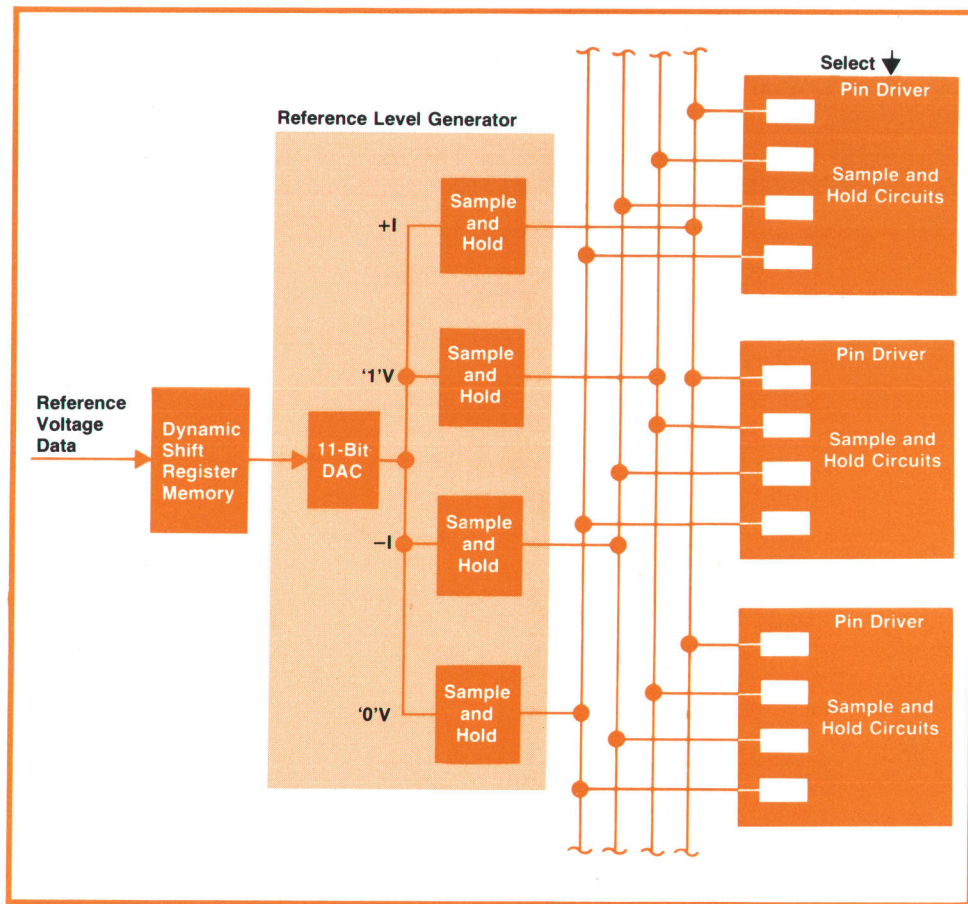

Fig. 10. Each pin driver requires four reference levels, which may differ from pin to pin. Reference levels are generated sequentially by a digital-to-analog converter and are picked off at appropriate times by sample-and-hold circuits.

reference voltage the output of the operational amplifier goes hard negative indicating a failure. In the one state a failure is indicated if the test pin voltage is lower than the reference voltage.

Reference Voltage Generator

Each pin driver requires four reference voltages, the zero and one reference voltages and the positive and negative current generator references. Each reference voltage can be set to different levels on all pins, so as many as $4 \times 24 = 96$ different voltages may be required. Fig. 10 shows how these voltages are generated. An MOS shift register memory stores the magnitude of each reference voltage. The shift register output is the digital input to an 11-bit digital-to-analog converter (DAC). As the shift register is clocked the reference voltages are sequentially generated at the output of the DAC. The output of the DAC is connected to four sets of sample-and-hold circuits that generate four parallel outputs representing the four reference voltages. These four outputs are bussed to the pin drivers so that the reference voltages for each pin driver appear in sequence. At the appropriate time, each pin driver picks off its reference voltages by means of its sample-and-hold circuits. The sample gates use CMOS bilateral switches.

Central Processor

Test programs for the 5045A IC Tester are written by HP factory specialists. The stimulus pattern and also the expected output pattern for the device under test are generated by programming the tester's central processor to emulate the logic of the device and the stimulus pattern generator or, alternatively, a truth table may be programmed for the stimulus and expected output pattern, or a mixture of both techniques may be used. Programming the logic enables large patterns to be generated algorithmically without the large amount of data storage that the corresponding truth table would require.

Programming the logic involves expressing the circuit to be programmed in terms of the logic elements that can be emulated by the arithmetic/logic unit (ALU) in the 5045A IC Tester, and then assigning nodal numbers to each logic element input and output. The logic program is then a list expressing in order the logic elements, the numbers of the nodes their inputs come from, and the nodal numbers of their outputs. Logic computation is done in the order that the program is written, so if an input depends on an output, the logic model that computes that output must be ahead of the input in the program. Sequential elements such as D and J-K flip-flops require storage of the state of the flip-flop and also the state of the

clock so that for the next state the presence of an edge on the clock input is known. Only as many inputs and outputs as are required for each logic element need be expressed in the program. Unused inputs are set to zero. If the nodal numbers for the inputs or outputs are in consecutive order, then the number of consecutive numbers is listed followed by the number of the first node, thus saving program space. For each change of state at the test socket, the logic program runs through once.

Operation of the processor as a logic simulator is illustrated in Fig. 11. The program tells the ALU what logic element to use and that inputs are being specified, so the RAM is set into the read mode. The number of consecutive steps is set up in the consecutive steps counter and the nodal number is preset into the address register. The nodal number corresponds to a RAM address, and the data stored in RAM (or its complement) is output to the ALU. This data is initially set to zero and changes as the test proceeds. If more than one consecutive step was programmed, then the consecutive steps counter keeps the program from advancing to the next step until the RAM address register has advanced through the programmed number of steps. When all the input statements in the program are complete for that logic element, the program specifies the output nodal number. The RAM then switches to write mode and the logic element outputs are stored in the RAM in the same way as the inputs were specified.

The program code is a 12-bit word of two types. The field of one specifies the logic element and the number of consecutive steps; the field of the other contains the nodal number, input/output, and true/complement bits. The word containing the logic element is usually followed by a number of words specifying the input nodes, then the logic element word, and as many output node words as are required. This leads to a structure where the data word is of variable length, which in a serial machine maximizes the speed, since time is wasted in a fixed-word-length serial processor in shifting bits of data that contain no useful information. The central processor is also used for doing housekeeping work under firmware control. In addition to being able to communicate with the ALU, the RAM can also communicate with the pin drivers, printer, and magnetic card reader.

Programs for the central processor can come from three sources, depending upon the state of the ROM address register, a presettable counter.

- Address 0-15—The HP-IB slot interface.
- Address 16-3071—The ROM firmware (contains all the housekeeping programs).
- Address 3072-4095—The IC test program memory. Normally the ROM address register steps sequentially through the ROM addresses. Jump statements and

conditional branch statements are executed by computing the new address in the RAM and then transferring it to the ROM address register.

Test Program Memory

The IC test program memory is a 6144-bit dynamic MOS shift register memory arranged in a 512×12 format. Information can be written from the test program memory into the RAM in serial form and read out in the same form, or memory data can be read onto the program bus in 12-bit parallel form. The memory does not have any address capability so the locations of blocks of data are identified by title codes. Searching for titles is done by a firmware subroutine.

If the memory is not being accessed, it does not shift. If it is not accessed for 0.5 ms, it goes into an automatic refresh mode; the information is recirculated until the stored information is back in the same locations as before.

An IC test program contains four types of information, the start of each being determined by its own title code. The first type lists the relays to be closed in the test head, the number of pins in the device under

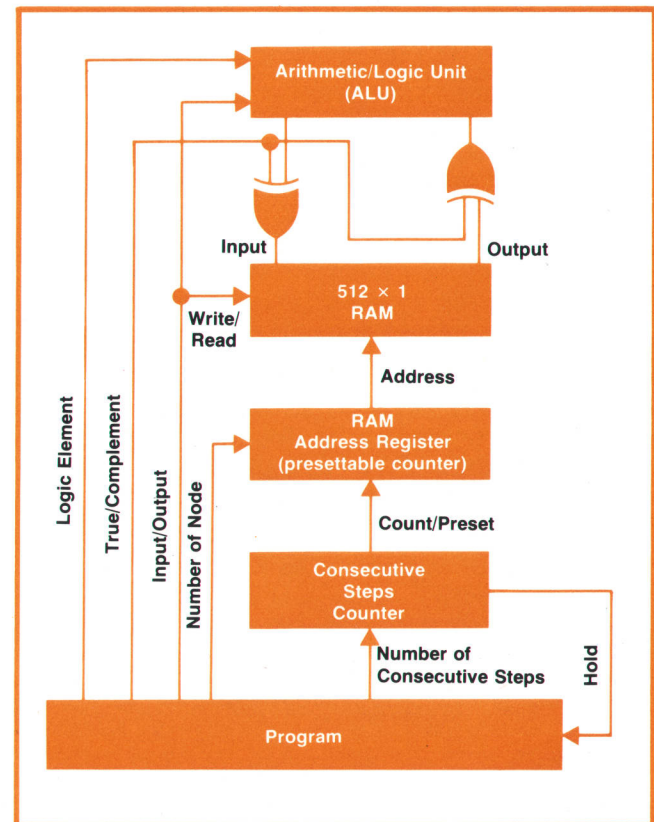

Fig. 11. Operation of the central processor when simulating the logic of the circuit under test and the stimulus pattern generator. The test program tells the ALU what logic element to simulate and whether to read the state of an input node from the RAM or write the state of an output node into the RAM. Logic simulation makes it possible to generate much larger test patterns than are feasible using truth tables.

test, and the name of the card, which is printed out when the card is loaded. The second type has the test name and calls out the parameter list and logic model to be used for that test. The third type is the parameter list for setting up the reference level generator, and the fourth is the logic model, which is output onto the program bus. The model tells the pin drivers what states to be in, either by simulating the logic of the stimulus pattern generator and the device under test, or by branching to a firmware subroutine which then inputs a section of the logic model as a truth table. Also, pins to be tested are specified and branches to time-delay subroutines in firmware can be programmed. Suppression of testing on all or some of the pins during a test can also be programmed.

Production Testing

Production testing of the 5045A IC Tester is done using a 9830A Calculator-controlled test system containing a digital voltmeter and a scanner and an HP-IB interface board plugged into the I/O slot in the tester. The test system automatically exercises each pin driver in all its operating modes and checks to see that the voltages and currents at the test socket are within the specified limits.

Acknowledgements

Many people contributed to the success of this project. Colin Chin assisted in hardware design. Dave Kook did the mechanical design. Earl Stutes contributed a compiler/assembler for writing IC test programs. Gary Gitzen, Tom Winegar, Bob Lane, and Russ

Aleshi wrote prototype test programs, and Jack Nilsson and many others are doing ongoing IC test program writing. Roy Criswell and Dick Harris handled the smooth introduction into production.

Lastly, the project could not have been completed without support and suggestions from section manager Gary Gordon and from Jesse Pipkin and Mark Baker in marketing. 



Eric M. Ingman

Eric Ingman was born in London, England and educated in Australia. After receiving his B. Eng. degree in 1959 from the University of Sydney, he returned to England for graduate work, then took a job in Australia designing communications equipment. He came to the United States and HP in 1964. Now project manager for the 5045A Digital IC Tester, Eric has designed several nuclear instruments and the 5376A Computing Counter Programmer. He's listed as inventor on one patent and two patent applications, the latter related to the 5045A. These days, Eric finds most of his spare time taken up by his family—he and his wife have two small children, a boy and a girl—and building an addition to his house in Los Altos Hills, California, but his Mooney Mark 21 aircraft remains his major hobby, just as it was six years ago when he wrote his first article for the Hewlett-Packard Journal.

Some Economic Considerations of IC Testing

Although integrated circuits are tested at several points in their manufacturing cycle, a certain percentage of the devices delivered to users are faulty. It may be said that to eliminate all defective ICs, the manufacturer need only test 100% of his devices before they are shipped. This is seldom true of any other manufactured product and is not true of integrated circuits. There seems to be a small percentage of defective devices that evade all controls. Unfortunately, this small percentage can cause serious trouble in systems where many ICs are used.

To see the effect of these defective devices, it is revealing to calculate the percentage of newly loaded printed circuit boards that will not function because they contain faulty devices. The probability of the total board working is the probability of all of its individual components working at the same time. This is derived by multiplying all the individual probabilities together. For example, a board containing 100 ICs, each with 99% probability of functioning correctly, would have a probability of functioning correctly of $(99\%)^{100}$, or 37%. This means that if only 1% of the ICs used to load the board are defective, only one out of three loaded boards will work when first turned on. If the boards contain 50 ICs that are faulty 1% of the time,

one out of three boards will be bad. Hence the rework costs directly attributable to faulty ICs can be quite sizable.

Equipment Costs

Several types of test equipment are available to detect faulty digital integrated circuits. As one might expect, inexpensive testers may be used to catch some of the failures, whereas equipment designed to eliminate virtually all failures may be prohibitively expensive to all but extremely-high-volume users. Functional testing, or testing to see whether a device performs according to its truth table, can be done with equipment in the \$1,000 price range. This type of testing catches an estimated 70% of all failures. The addition of dc parametric testing, or testing to see whether all input/output voltages and currents are correct and ascertaining that the device will operate under worst-case voltage and current conditions, catches greater than 95% of all faulty devices. A tester that performs both parametric and functional tests costs about \$10,000. The Model 5045A Digital IC Tester is in this class.

To catch the last few faulty devices it is necessary to add pulse parametric or dynamic testing to the test repertoire. Addition of this test segregates those devices whose defects

are slow rise times, long propagation delays, insensitivity to narrow clock pulses, or other timing-related phenomena. This type of tester costs typically over \$100,000. For most IC users, the most cost-effective solution is a compromise between the two extremes: a bench-top digital IC tester capable of performing dc parametric and functional testing, thereby catching greater than 95% of all faulty devices.

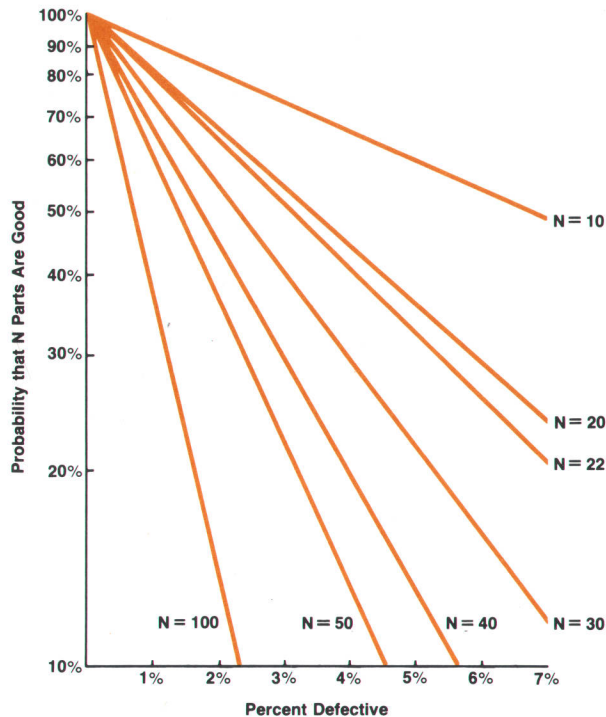

Sample Testing or 100% Testing?

There are two schools of thought regarding the quantity of a given lot that should be tested once it is received from the vendor. Sample testing is designed to catch gross defects such as high percentages of devices that do not meet specifications or devices that are mismarked. Small percentages of defective devices may not be detected. This type of testing is usually done when the lot of ICs is purchased as having an acceptable quality level (AQL). For example, 0.65% AQL means that a lot that is 0.65% defective has a 95% chance of being acceptable by the user. It also means that a lot that is 2% defective has a 50% chance of being accepted and a lot that is 4.8% defective has a 10% chance of being accepted. If a lot is rejected by the user because his sample testing reveals excessive failures, the whole lot is returned to the vendor. This lot is then replaced by another lot that may pass the sample test even though it contains a small percentage of faulty devices, a percentage that may be quite significant.

100% testing is more expensive, since it typically involves automatic handling equipment and requires more of a labor investment, but it does have the advantage of catching not only the gross problems but also the small percentage of defects that are continuously present. Although the trend seems to be towards 100% incoming inspection of digital ICs, the user's

decision must be based on a careful analysis of his individual situation.

The Cost of 100% Testing Using dc Parametric and Functional Tests

The cost of testing a digital IC depends primarily on two things: the cost of the test equipment involved and the cost of the manpower required to operate the equipment. The cost of testing a single IC can then be determined according to the volume of ICs tested and the speed at which they are tested. For equipment costs, assume the IC tester costs \$10,000 and the addition of automatic handling equipment to the tester costs \$8,000. For labor costs, assume a \$4/hour rate with 50% overhead for a total of \$6/hour. The low-volume user of ICs, testing 50,000 ICs per year, would probably choose to insert the ICs into the tester manually. Using five-year straight-line depreciation, the annual equipment costs would be \$2,000, or .04/IC. About 300 ICs can be tested per hour for \$6 or .02/IC. The total testing cost is .06/IC. The high-volume user of ICs, testing 1,000,000 ICs per year, would require automatic handling equipment in addition to the IC tester for a total of \$18,000. The annual equipment depreciation would be \$3,600 or .0036/IC. About 4,000 ICs could be tested per hour for \$6 or .0015/IC. The total testing cost is .0051/IC. For the assumptions stated, the high-volume user could buy testing for each of his ICs at one-tenth the cost of the low-volume user. Even so, the cost to the low-volume user may prove to be a good investment.

The Cost of Finding a Bad IC

The cost to find a bad IC at incoming inspection depends on the cost of testing a single IC and the failure rate of the IC type. For a typical failure rate of 1% for room-temperature dc parametric and functional testing (high-temperature testing usually produces more failures), 100 ICs must be tested to find a bad one. For the user of 50,000 ICs per year, the cost to find that one bad IC is \$6 (from the analysis above). For the user of 1,000,000 ICs per year, the cost to find that one bad IC is \$0.51. These testing costs may now be compared to costs of finding and replacing a faulty IC once it is soldered into a circuit board. An estimate of \$10 per board repair is representative of a typical cost that might be incurred *if the faulty device is caught in the factory.*

For a company using 50,000 ICs per year the cost to find each bad IC is \$6 for a 1% failure rate. With this failure rate, 500 faulty devices would be found per year, saving an estimated \$5,000 in board repair costs. The cost to find these 500 bad ICs is \$3,000 for a net savings of \$2,000. Since the costs are fixed, higher failure rates than 1% mean more savings. For a company using 1,000,000 ICs per year the cost to find each bad IC is \$0.51 for a 1% failure rate. Testing the one million circuits yields 10,000 bad ICs for a savings of \$100,000 in board repair costs. The cost to find these 10,000 bad ICs is \$5,100 for a net savings of \$94,900. For the two situations analyzed, the savings are then \$2,000 to \$94,000. Thus the potential for cost savings is very great.

Mark Baker

SPECIFICATIONS

HP Model 5045A Digital IC Tester

TEST SET-UP METHOD: Preprogrammed magnetic card. All test conditions including parametric information, input stimuli, and corresponding outputs are contained on the card. The program is verified each time it is loaded.

LOGIC FAMILY COMPATIBILITY: Compatible with ECL, CMOS, TTL, DTL, HTL, RTL and the associated sub-families. See the IC Program Catalog for available programs.

LOGIC FUNCTION COMPATIBILITY: Gates, flip-flops, monostable multivibrators, counters, shift registers, priority encoders, Schmitt triggers, parity generators/checkers, decoders/encoders, optical isolators, dual-in-line reed relays, adders, arithmetic logic units, ROM's, PROM's, static RAM's, and many more.*

DUAL TEST FOR EACH IC: Two tests are supplied in the test package for each circuit. Each test is on a separate card. "Pass/Fail" for a minimum test time; "Diagnostic" for the same test with more detailed circuit failure analysis.

TEST STRUCTURE:

FUNCTIONAL TESTS: Truth table is verified by direct comparison between the output of a software generated IC simulator (or stored truth table for certain circuits) and the output of the device under test.

PARAMETRIC TESTS: All dc parameters (voltages and currents) are tested to the manufacturers' data sheet specifications except where limited by the specifications of the Tester. Test limits are indicated in the information accompanying each magnetic card.

CONTINUITY TEST: Verifies pin contact by checking for the presence of current flow into or out of all active pins (failure of this test is shown on the "CONT" indicator).

TEST PATTERN GENERATION: Test patterns are derived through algorithmic techniques or from stored truth tables and are individually tailored to each IC.

PASS/FAIL COUNTER: Prints the number of passed and failed devices. Count is initiated when the magnetic card is inserted.

UNIVERSAL PIN DRIVERS: Note: The same circuit is used for driving and monitoring a pin whether that pin is input, output, power supply, or clock. All voltages and currents can be set individually and uniquely on each pin. External test fixtures are not required.

VOLTAGE APPLIED TO THE DEVICE UNDER TEST: (Supply Voltage, Input Voltage, and Output Voltage)

RANGE	ACCURACY
-7.5V < to < -1.875V	±25 mV
-1.875V < to < +1.875V	±15 mV
+1.875V < to < +7.5V	±25 mV

CURRENT APPLIED TO THE DEVICE UNDER TEST: (Supply Current, Input Current, and Output Current)

RANGE	ACCURACY
-200 mA < to < -2.5 mA	±0.4 mA or ±6%**
-2.5 mA < to < +2.5 mA	±10 µA or ±6%**
+2.5 mA < to < +200 mA	±0.4 mA or ±6%**

SLEW RATE: 30 ns/volt

DIGITAL VOLTMETER/MILLIAMMETER FOR FAILED PINS: When a failure is encountered (with **PRINTER: ON, V and I RESULTS: ON**), the printing digital Voltmeter/Milliammeter records the voltage and current present on the failed pin(s). In addition, the 5045A reduces the driving parameter which caused the failure (voltage for input pins, current for output pins) until the device no longer fails. The second voltage/current pair is also recorded.

VOLTAGE:	RANGE	ACCURACY
	-7.5V < to < -1.875V	±35 mV
	-1.875V < to < +1.875V	±15 mV
	+1.875V < to < +7.5V	±35 mV

CURRENT:	RANGE	ACCURACY
	-200 mA < to < -2.5 mA	±0.4 mA or ±6%**
	-2.5 mA < to < +2.5 mA	±10 µA or ±6%**
	+2.5 mA < to < +200 mA	±0.4 mA or ±6%**

REAR PANEL OUTPUTS: Automatic Handler Interface: 14 pin Amphenol connector provides "End of Test", "Pass", "Fail" and "Fail Continuity" signals and accepts "Start Test". Also available is a +5V line capable of supplying up to 200 mA.

General

POWER: 100/120/200/240V (+5%, -10%), 48-66 Hz, 250 VA.
DIMENSIONS: 19 cm high, 42.5 cm wide, 58 cm deep (7.5 in. × 16.7 in. × 22.8 in.)
SHIPPING WEIGHT: 39.1 kg (86 lb)
NET WEIGHT: 27.7 kg (61 lb)

OPERATING Temperature: 0°C to 50°C

RELATIVE HUMIDITY: 50%

PRICE IN U.S.A.: \$5900 plus options.

OPTIONS AND ACCESSORIES:

OPTION 004†: Interface package for IPT Model 800 Automatic IC Handler. \$1000.

OPTION 005†: Interface package for Sym-Tek Model 7191ND Automatic IC Handler and other related models. \$1000.

OPTION 006†: Interface package for Daymarc 952/3 Automatic IC Handler. \$1000.

OPTION 007†: Interface package for Siemens (MCT) Model 2608 Automatic IC Handler. \$1000.

OPTION 024: Expands the capability of the 5045A to 24 pins. \$2000.

OPTION 908: Rack flange kit. \$10.

OPTION 910: Set of additional product manuals. \$30.

9164-0071: Blank magnetic program card (Pass/Fail). \$2.

9164-0072: Blank magnetic program card (Diagnostic). \$2.

9281-0401: 250 foot roll of thermal print paper (minimum order six rolls). \$2.20 ea.

10845A: Preprogrammed magnetic card for any device listed in the IC Program Catalog. The specific cards required are designated on the program card order sheet. 1-9, \$30. 10-500, \$25.

10846A: Coupon book containing ten coupons each redeemable in one preprogrammed magnetic card which is listed in the IC Program Catalog. The coupons are mailed directly to the factory and the appropriate program card is returned by airmail. The coupons expire two years from the date of receipt. \$250.

MANUFACTURING DIVISION: SANTA CLARA DIVISION
 5301 Stevens Creek Boulevard
 Santa Clara, California 95050 U.S.A.

*Some circuits require the optional 24 pin capability.

**Whichever is greater.

†All interface packages include a test head extender cable, an interface board unique to the particular handler, and a cable to supply the control signals to the handler. This enables the test head electronics to be mounted within inches of the device under test.

Hewlett-Packard Company, 1501 Page Mill Road, Palo Alto, California 94304

Bulk Rate
 U.S. Postage
 Paid
 Hewlett-Packard
 Company

HEWLETT-PACKARD JOURNAL

OCTOBER 1976 Volume 28 • Number 2

Technical Information from the Laboratories of
 Hewlett-Packard Company

Hewlett-Packard S.A., CH-1217 Meyrin 2
 Geneva, Switzerland
 Yokogawa-Hewlett-Packard Ltd., Shibuya-Ku
 Tokyo 151 Japan

Editorial Director • Howard L. Roberts
 Managing Editor • Richard P. Dolan
 Art Director, Photographer • Arvid A. Danielson
 Illustrator • Linda B. Chapa
 Administrative Services, Typography • Anne S. LoPresti
 European Production Manager • Michel Foglia

CHANGE OF ADDRESS: To change your address or delete your name from our mailing list please send us your old address label (it peels off). Send changes to Hewlett-Packard Journal, 1501 Page Mill Road, Palo Alto, California 94304 U.S.A. Allow 60 days.